



え み

か

ぜんぶ か

おほ

も

絵を見て、ていねいに「ひらがな」をまねて書きましょう。全部書けたら「ひらがな」のかたちをよく覚えましょう。

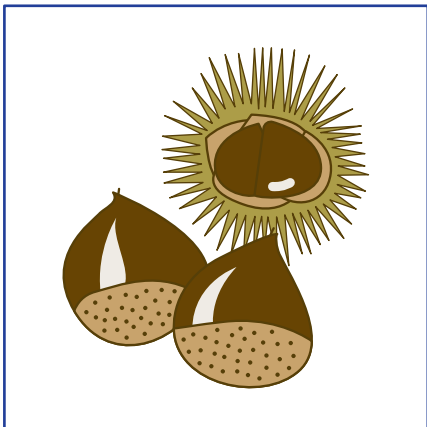

り

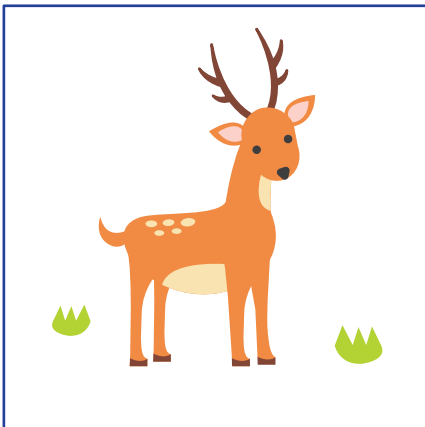

か

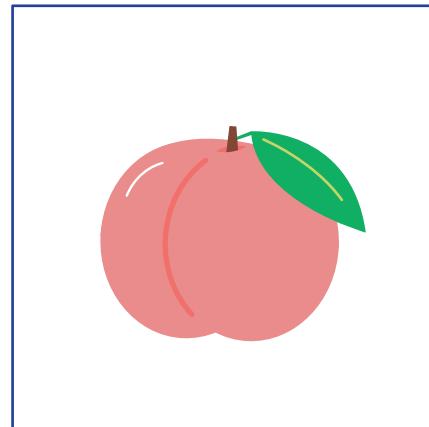

も

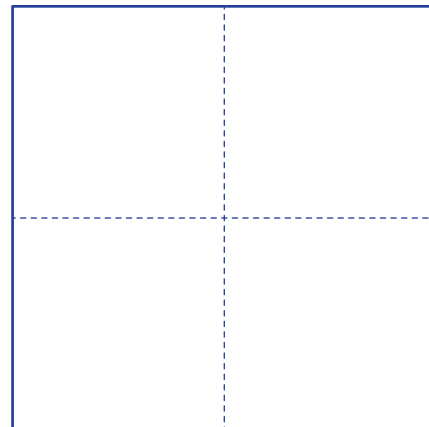
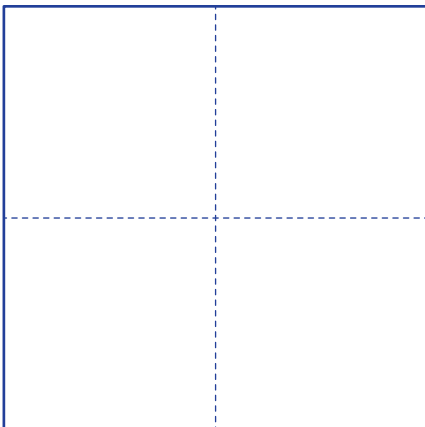
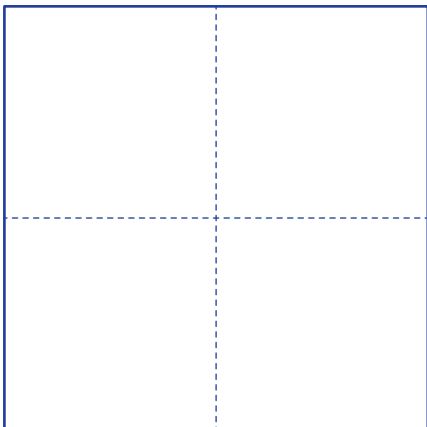
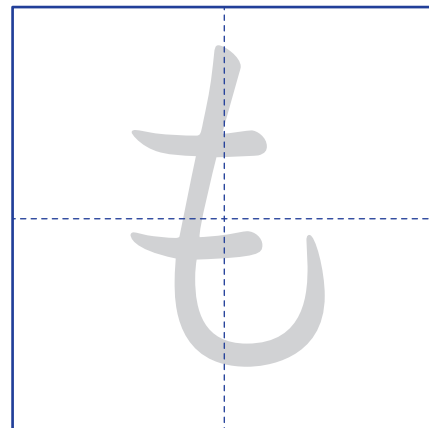
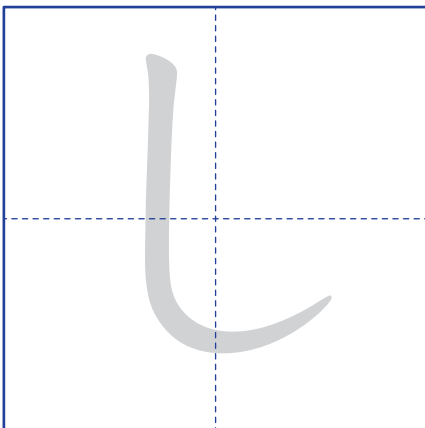
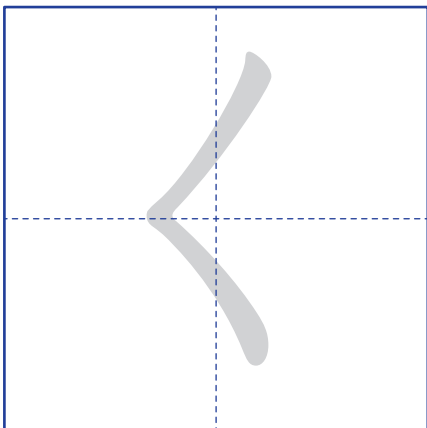



え み 絵を見て、ていねいに「カタカナ」をまねて書きましょう。全部書けたら「カタカナ」のかたちをよく覚えましょう。

か

ぜんぶ か

ち

おぼ

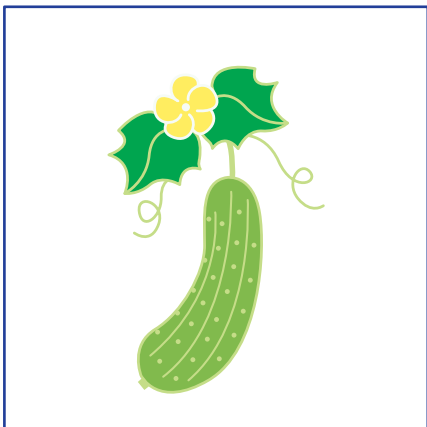

○
チ
マ

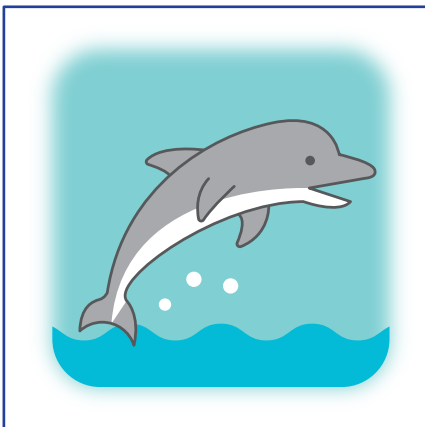

○
ル
カ

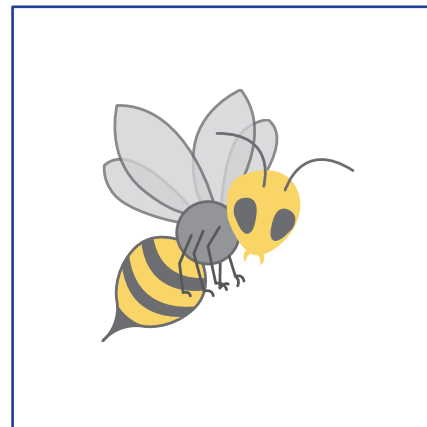

○
チ

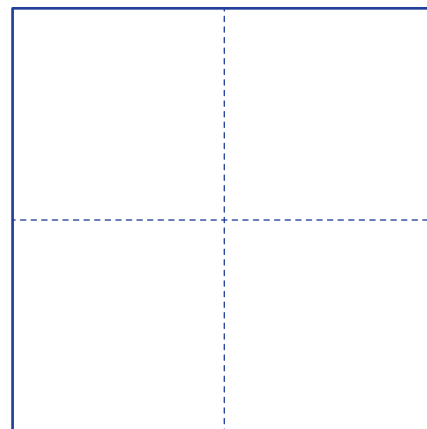
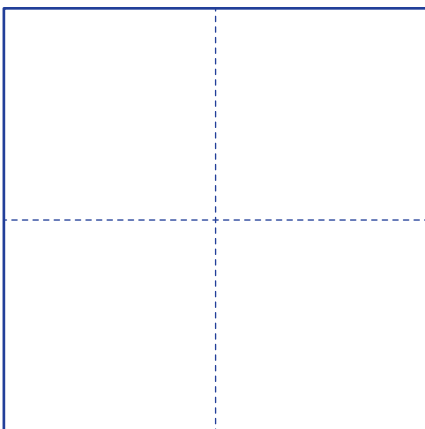
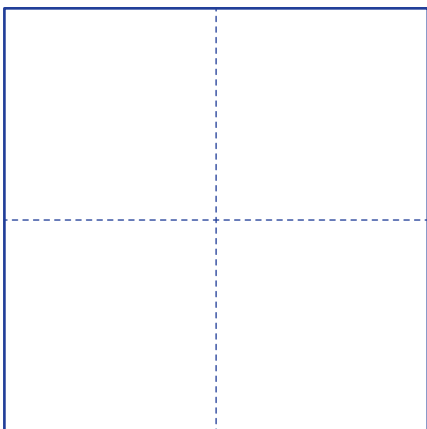
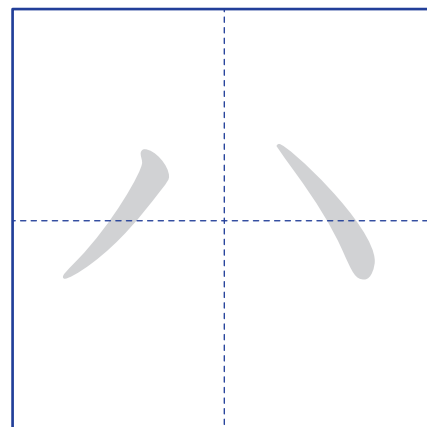
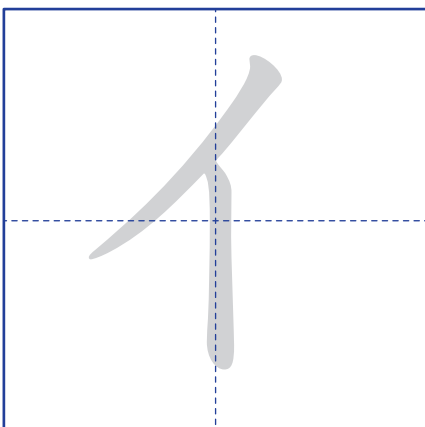
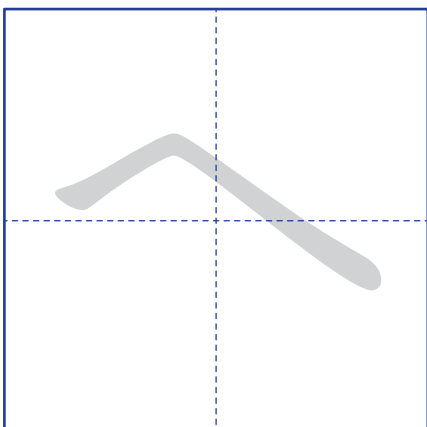



かぞ ぞ
ドツツを数えて、ていねいに「すうじ」をまねて書きましょう。ぜんぶ か
おほ
●●● ●●● ●●●
全部書けたら「すうじ」のかたちをよく覚えましょう。

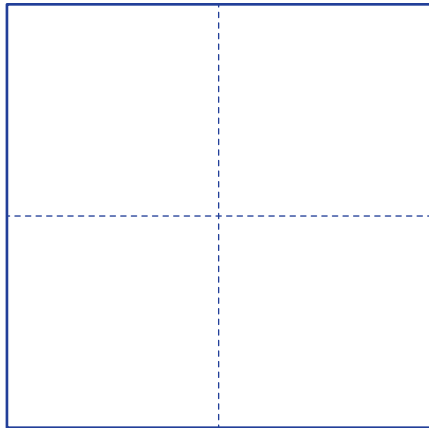
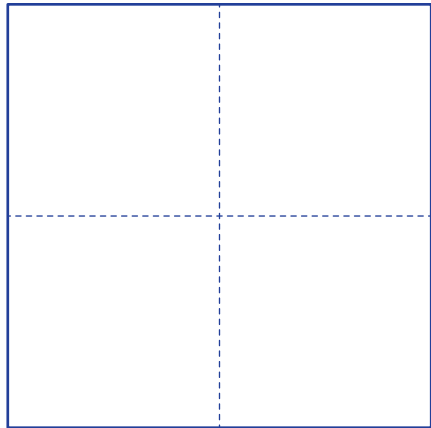
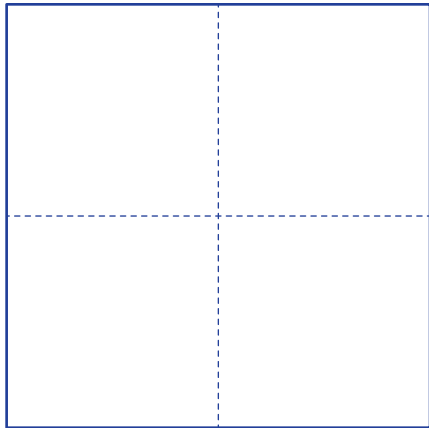
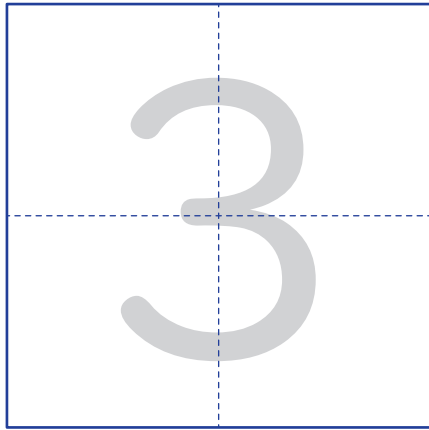
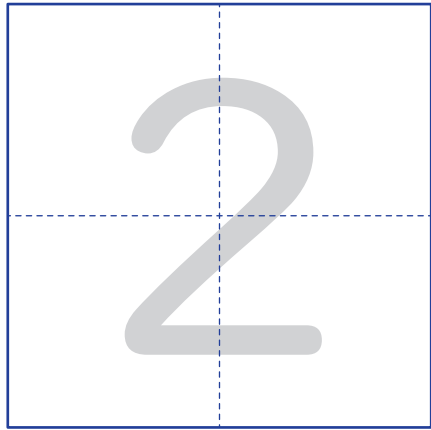
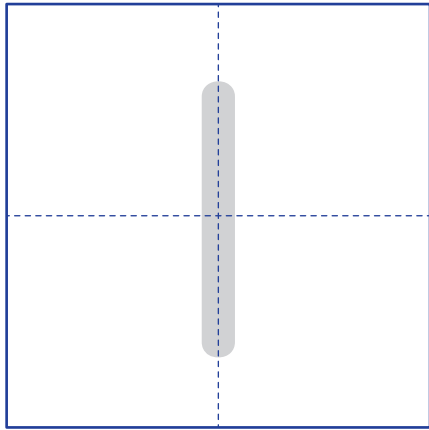
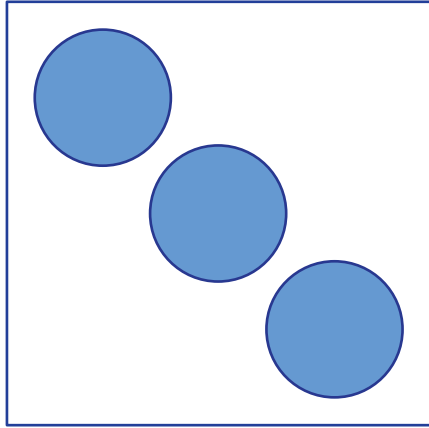
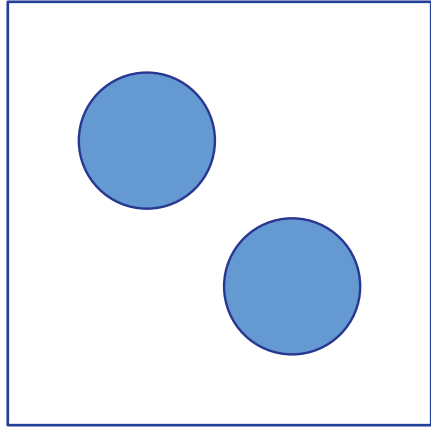
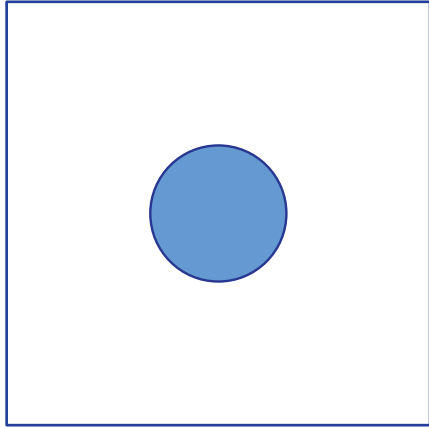



ずけい み した なか か ぜんぶ か ずけい じゅん おぼ
図形をよく見て、その下の□の中にまねて描きましょう。全部描けたら図形のかたちを順に覚えましょう。

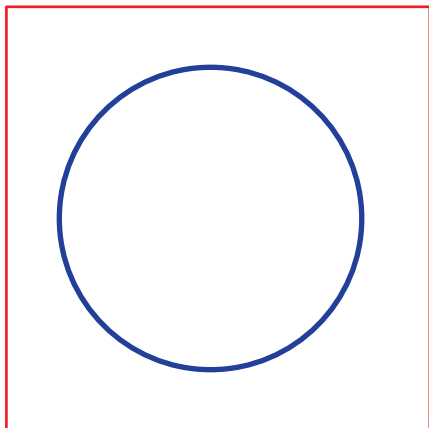

まる

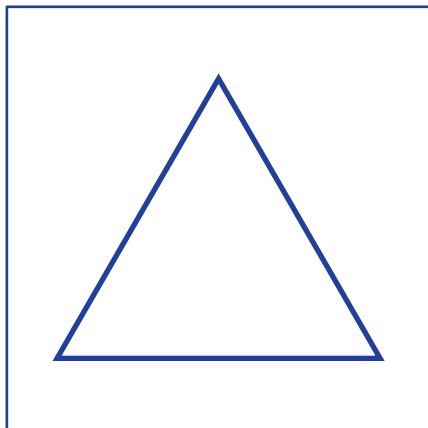
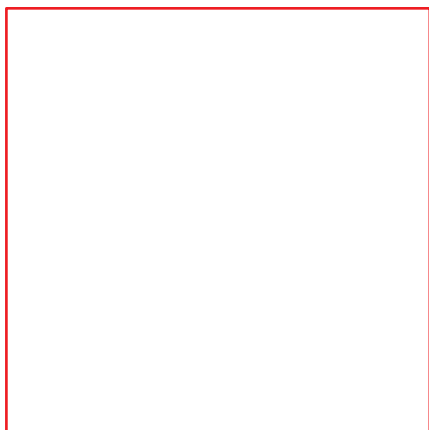
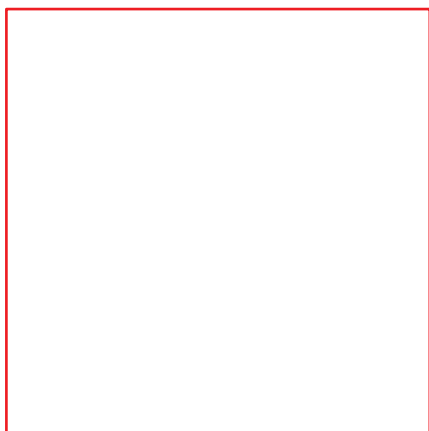

さんかく

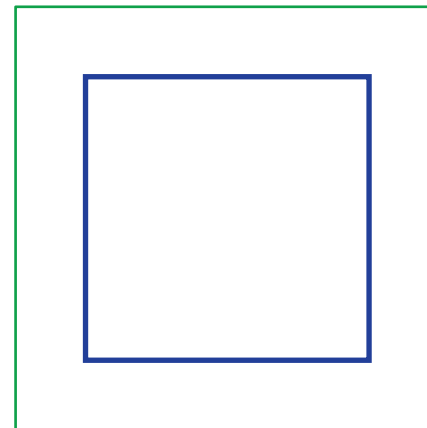
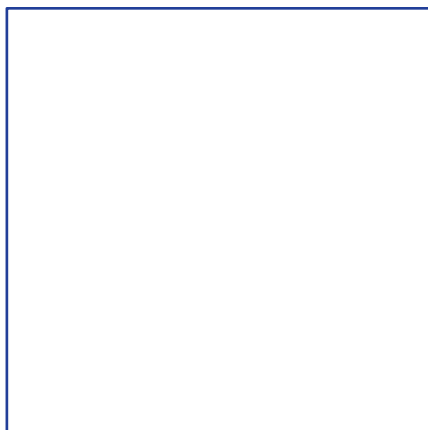
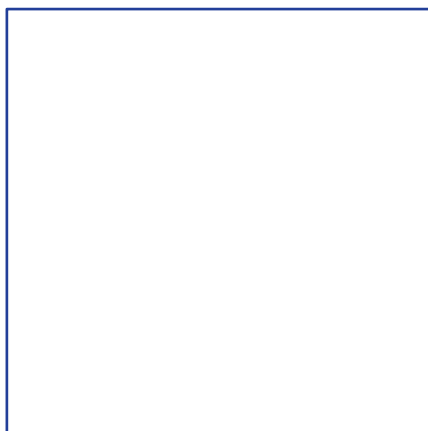

しかく





め なか いち み した め なか おな か じゅん か
マス目の中の○の位置をよく見て、その下のマス目の中に同じように○を描きましょう。(→の順に描いていきましょう。)
ぜんぶ か め なか いち おぼ
全部描いたらマス目の中の○の位置を覚えましょう。

